



Phonemic Awareness

Whirrrr



Visit www.newpathlearning.com for Online Learning Resources.
© Copyright NewPath Learning

TABLE OF CONTENTS

Lesson 1 - Sounds - Same & Different	2
Lesson 2 - Letter Sounds.....	6
Lesson 3 - Beginning Sounds	10
Lesson 4 - Ending Sounds	14
Lesson 5 - Vowel Sounds.....	18
Lesson 6 - Word Parts.....	22
Lesson 7 - Counting Syllables.....	26
Lesson 8 - Onsets & Rimes	30
Lesson 9 - Phoneme Segments	34
Lesson 10 - Rhyming Words	38
Bonus Pages	42

Teacher Notes

The activities in this guide help early childhood learners develop an understanding of phonemic awareness. They are designed to supplement the study of phonemic awareness skills. Each lesson features a different skill, including initial, ending, vowel sounds and the ability to discriminate letter sounds, division of sounds, syllables, among others.

This guide is an ideal resource for centers, independent work in the classroom or homework. The activities can be used independently for review or as a form of assessment or in combination with other related classroom activities. They are also the perfect complement to *NewPath's Early Childhood Flip Charts*, available separately at www.newpathlearning.com.



Phone: 800-507-0966

Fax: 800-507-0967

www.newpathlearning.com

NewPath Learning® Products are developed by teachers using research-based principles and are classroom tested. The company's product line consists of an array of proprietary curriculum review games, workbooks, charts, posters, visual learning guides, learning centers, interactive whiteboard software and other teaching resources. All products are supplemented with web-based activities, assessments and content to provide an engaging means of educating students on key, curriculum-based topics correlated to applicable state and national education standards.

Copyright © MMXVIII NewPath Learning. All Rights Reserved.

Printed in the United States of America.

sounds - same & different

loud



quiet



sounds that are similar



buzzzzz



woowooowoo

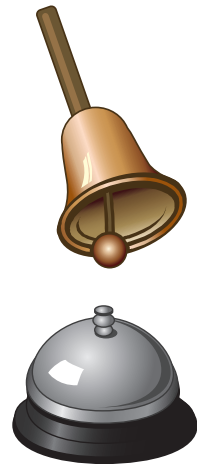

ding ding

sounds that are different



whirrrr

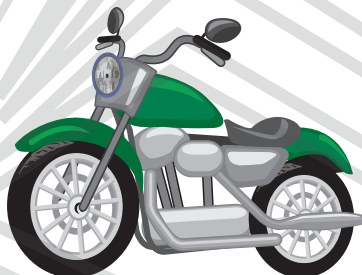

vroom

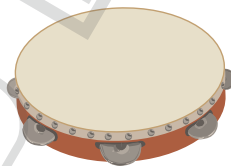

jingle jangle



toot

cock-a-doodle-doo

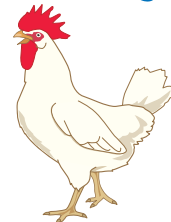

oink
oink

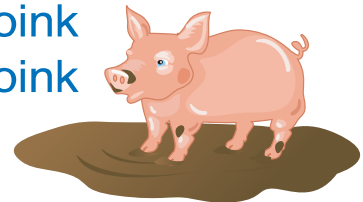

sounds - same & different

Circle the same kind of sounds.

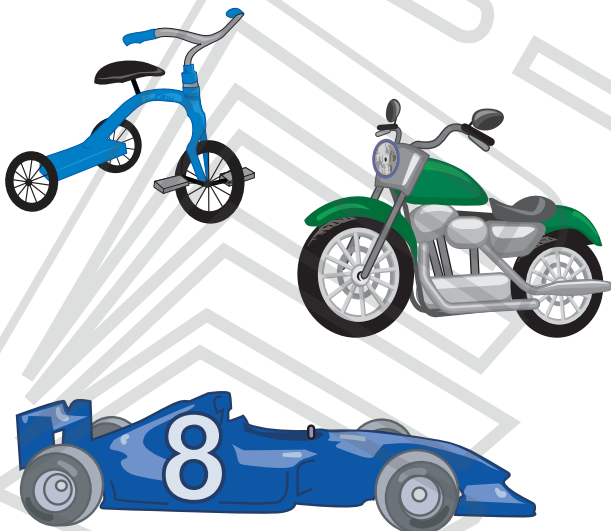
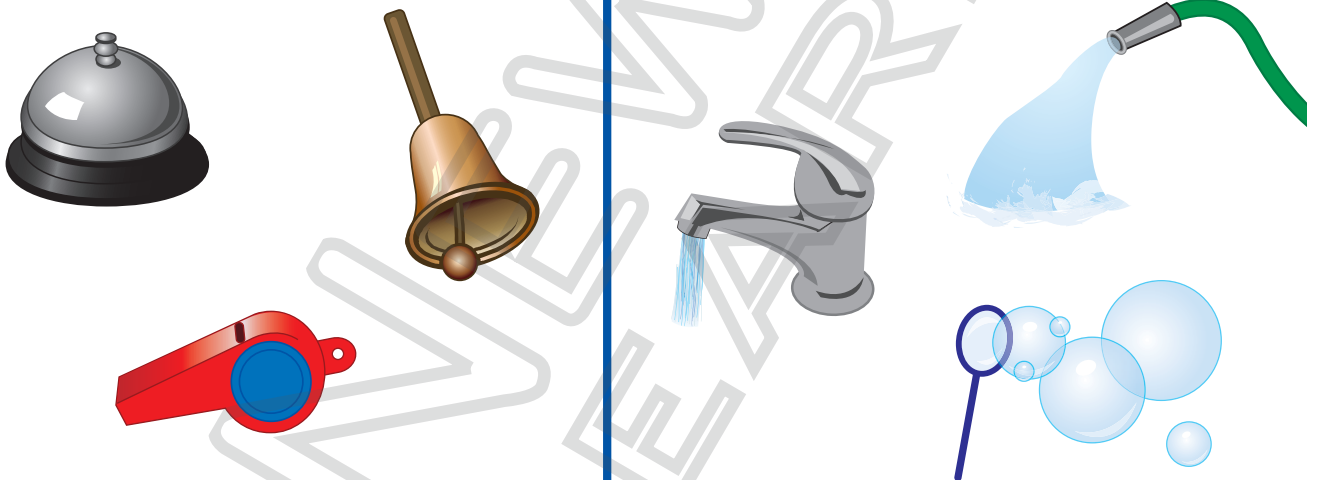
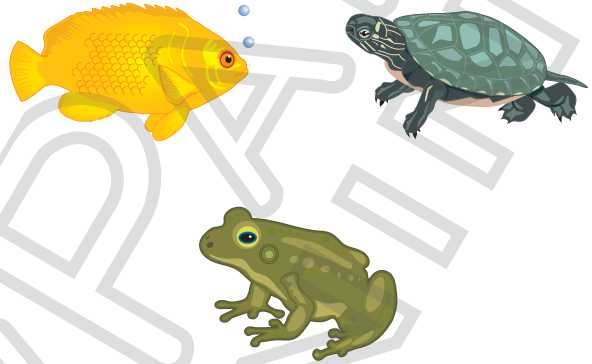

Sounds - Same & Different - Color it!

loud

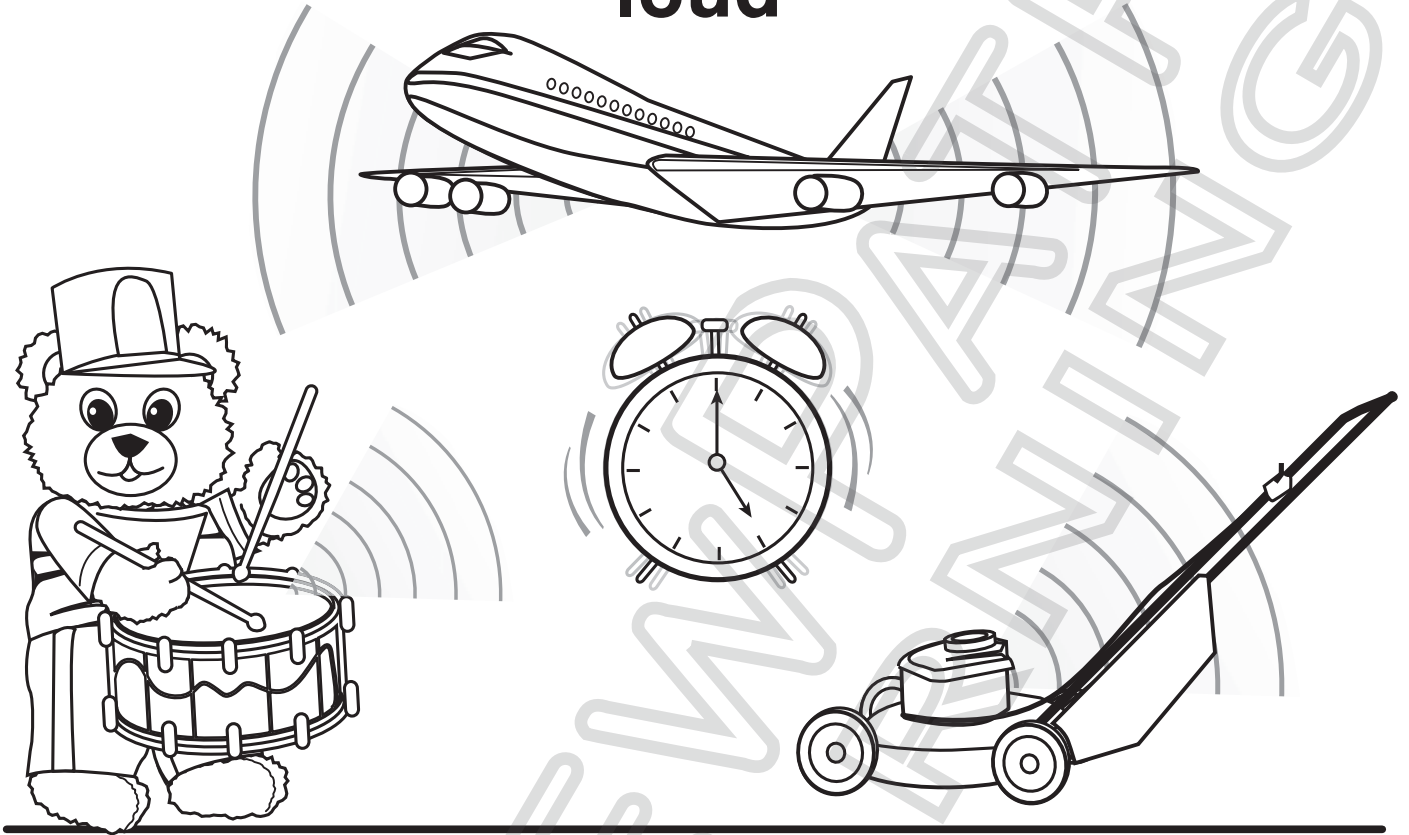

quiet

